



Place these instructions in vehicle's glove box after installation is complete



Installation Time: Approx . 60 Minutes



Care Instructions:



Clean Tonneau Cover with a mild detergent and water solution.



Do not use abrasive cleaners or solvents.

WARNING!

When in the closed position, Aluminium Tonneau Cover must be latched and tailgate must be closed. Failure to do so could result in unexpected opening of the Tonneau Cover from sudden wind gusts or driving conditions, which could cause damage to the vehicle and/or your Aluminium Tonneau Cover.

Secure any items tall enough to strike the Tonneau Cover lock mechanism.

DO NOT close the Tailgate when the Aluminium Tonneau is in the closed position, as damage may occur to the vehicle and/or your Tonneau Cover.

Do not operate vehicle while cover is open.

MAINTENANCE:

- Avoid the use of chemicals to clean painted surfaces, wash regularly with car wash detergent, hose off and chamois dry. Aluminium top sheet finish can be maintained with briteshine polish or similar. Un-maintained product i.e. surface finish degradations not covered by warranty.
- The gas struts are self lubricating and should only be cleaned occasionally with a damp cloth. Premature seal failure will result if solvents or lubricants are used to clean struts.
- Gas struts must be connected with the cylinder (wide) end to the Aluminium Tonneau Cover or Warranty is Void.
- The locking mechanisms and latches only require occasional lubrication with Graphite Powder.
- DO NOT use any other lubricants or oils. Using alternative products will VOID Warranty.
- All installation hardware and fasteners must be checked every so often for tightness.

TONNEAU COVER - IMPORTANT:

- Read instructions carefully before installation. It is strongly recommended that installation is conducted by a qualified mechanic.
- This product must be installed exactly as specified in these instructions. Failure to do so may result in improper fit and/or retention.
- Do not stand/sit or rest heavy objects on Tonneau Cover.
- Humans or animals are not to be under the closed Tonneau Cover at any time.
- Securely latch Tonneau Cover before operating vehicle.
- Do not carry open volatile chemicals with Tonneau Cover installed.
- If contact with volatile chemicals occurs clean Tonneau Cover with mild detergent and water solution.
- Recommend installation by 2 people.
- Fitting Instructions must be given to the end customer to understand correct removal and replacement process onto the vehicle.



For Rngr (T6) and Maz BT50 (B32) Dual Cab - Aluminium Tonneau Cover

Double Cab/Dual Cab - ATC0003 (silver) ATC0004 (Black)
Super Cab/Freestyle Cab - ATC0015 (silver) ATC0016 (Black)

Tonneau Cover Assembly x1

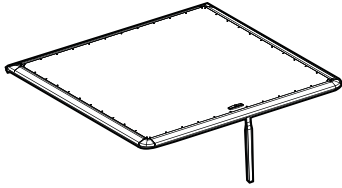

Hinge Bracket x2

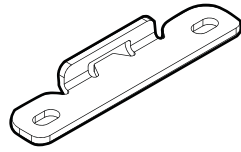

Striker Bracket x2

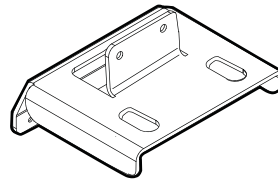

Striker x2

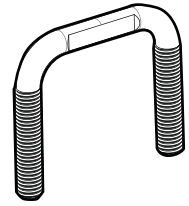

M10 Nut x8

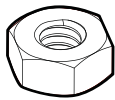

M10 Washer x8



Gas Strut x2

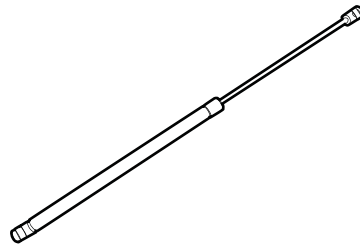

Ball Stud x4

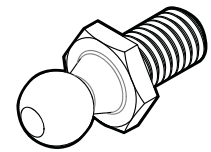

M8 Lock Nut x4



M8 Washer x2



Gas Strut Bracket x2

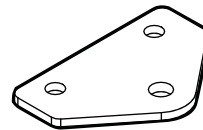

M6 Button Head Cap Screw x4

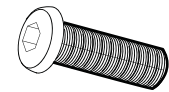

M6 Washer x4



M6 Nut Plate x2

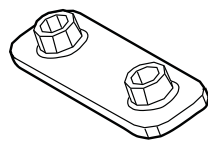

4.8x10 Rivets x16

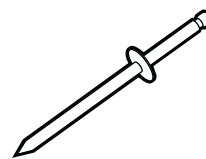

Tailgate Lock Bracket x2

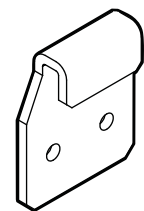

Foam Pad x1

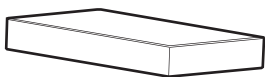

REQUIRED TOOLS | EQUIPMENT

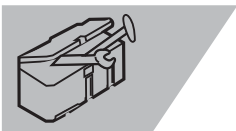

13mm and 17mm Socket

4mm Allen Key

Cleaning Materials

½" Drive Ratchet + Extension Bar

Rivet Gun

Masking Tape

8mm, 13mm and 17mm Spanner

Tape Measure

Right Angle

Power Drill

Centre Punch

Rust Inhibitor



5mm Drill Bit

Hammer

Personal Protective Equipment:

8 mm Drill Bit

Pencil / Marker

Safety Glasses, Ear Plugs, Gloves

(Scissors, Silicone)* Optional

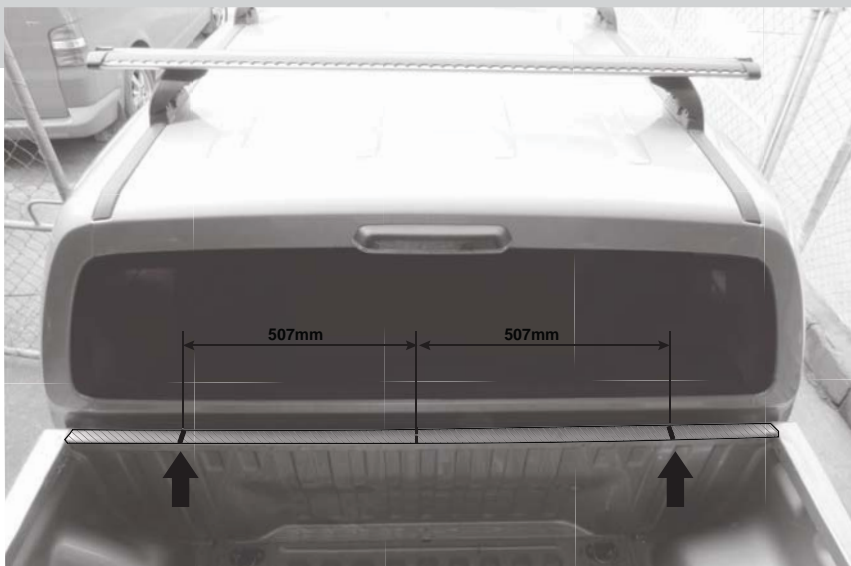

Step 1

Required tools: Masking Tape, Marker Pen and Tape Measure.

1. Clean the top surface of the tub.
2. Apply masking tape on front rail top surface and mark a centre line accurately. Mark lines 507mm from the centre line to both sides.

NOTE: This instruction is for plain tub installation only. If tub liner is fitted, the liner will need to be trimmed to allow correct installation of the tonneau cover brackets and hinges. No spacers or additional media allowed between hinges/brackets and the vehicle tub.

NOTE: If fitted, cabin guard must be removed.

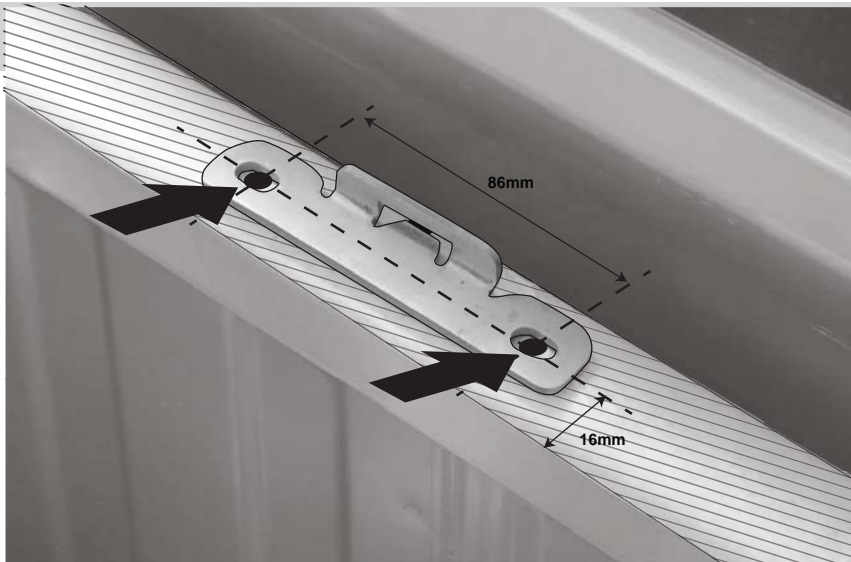

Step 2

Required tools: Marker pen, tape measure, right angle.

1. Mark another line 86mm outboard from this line, and a line 16mm from front rail inner surface, crossing both lines (use right angle and tape measure). Repeat for both sides.
2. Align Hinge Bracket to marked lines and check alignment. Repeat both sides

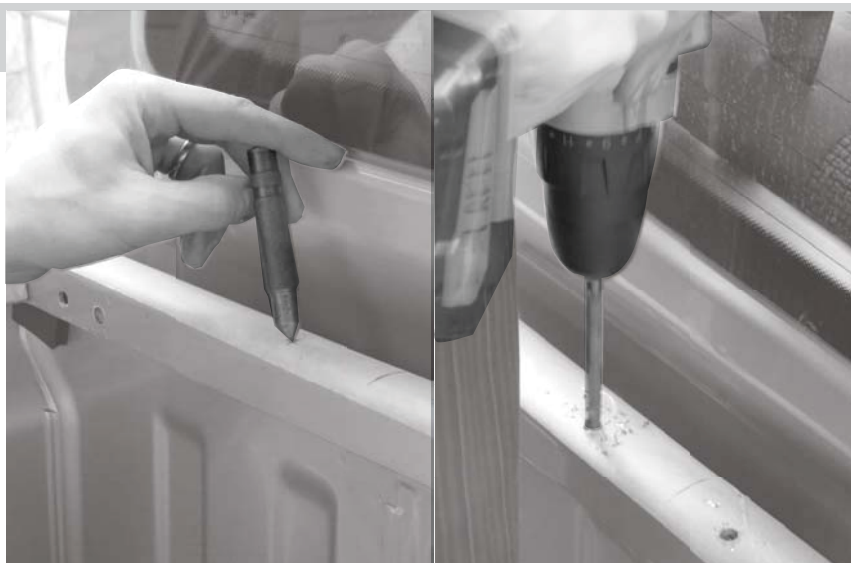

Step 3

Required tools: Power drill, 8mm drill bit, centre punch, hammer.

1. Centre punch hole locations (4x)
2. Drill through using 8.0mm drill bit and remove drill burr from the holes.
3. Apply rust inhibitor to the drilled holes.



Step 4

Required tools: 4mm Allen Key.

1. Position hinge bracket and secure with supplied M6 bolts, washers and nutplate. Finger tighten only. Repeat both sides.
2. Align both Hinge Brackets equal from the front rail inner surface and tighten the bolts to 10Nm. Repeat both sides.

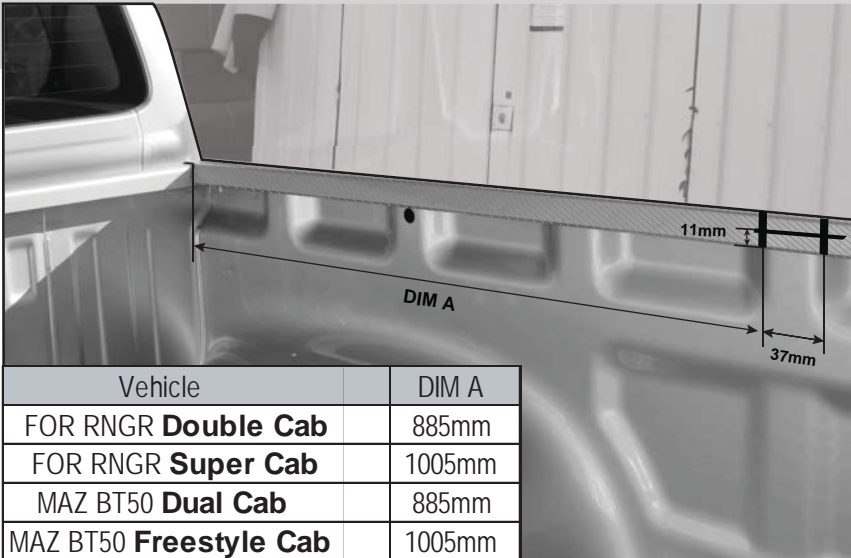

Step 5

Required tools: Tape Measure, Marker Pen and Masking Tape.

1. Apply masking tap to the side rail inner
2. Select the relevant 'DIM A' for your vehicle from the table (left). Starting at the front rail inner surface, use the relevant 'DIM A' to make a mark on the inner side rail as shown.
3. Mark another line 37.0mm from this line, and a line 11.0mm from the side rail bottom edge, crossing both lines.
4. Repeat for both sides.

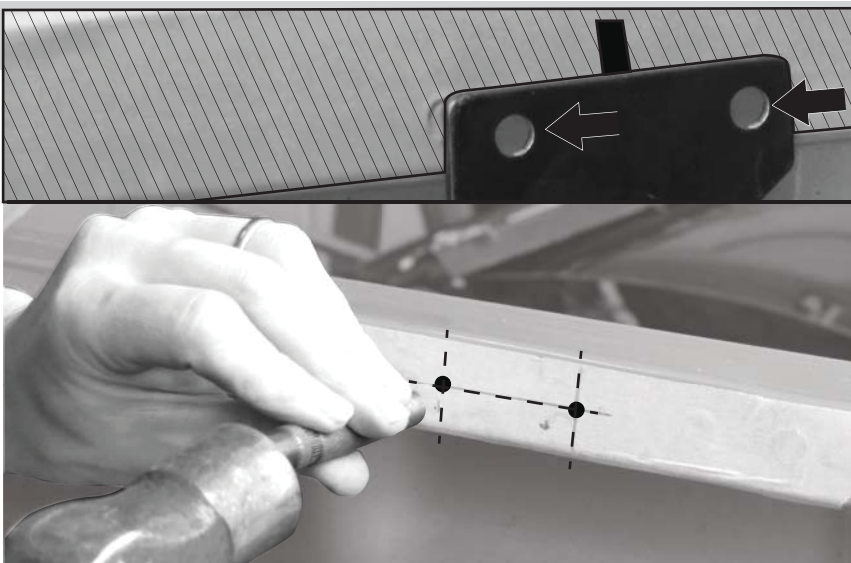

Step 6

Required tools: Centre Punch, Marker Pen, 5mm Drill Bit and Power Drill.

1. Align Gas Strut Bracket with marked lines to confirm hole locations.
2. Mark and centre punch hole locations.
3. Drill holes through using 5.0mm drill bit, and remove any drill burr from holes.
4. Repeat for both sides.
5. Apply rust inhibitor to the drilled holes.

Step 7

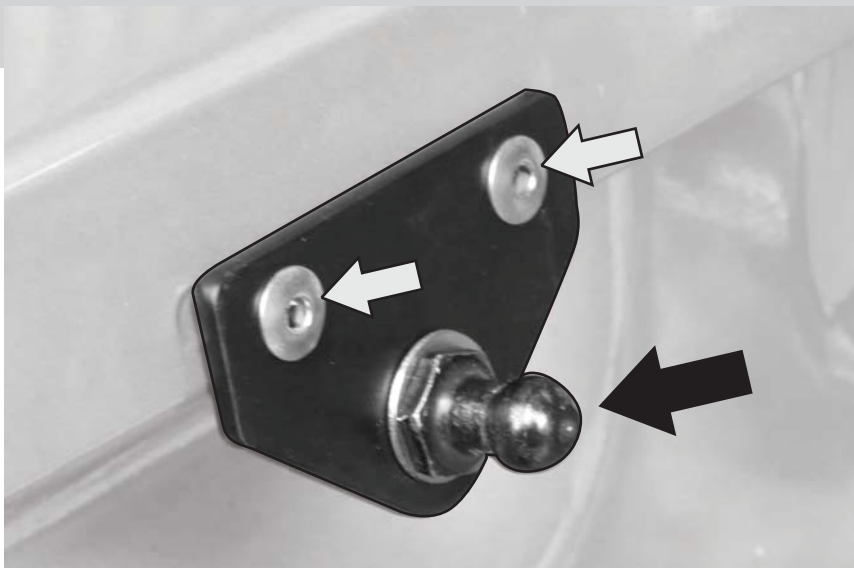

Required tools: Rivet gun, 13mm spanner and 13mm socket and driver.

1. Install the gas strut bracket with supplied rivets.
2. Install the pivot end ball to the bracket and tighten it to 20.0 Nm

Step 8

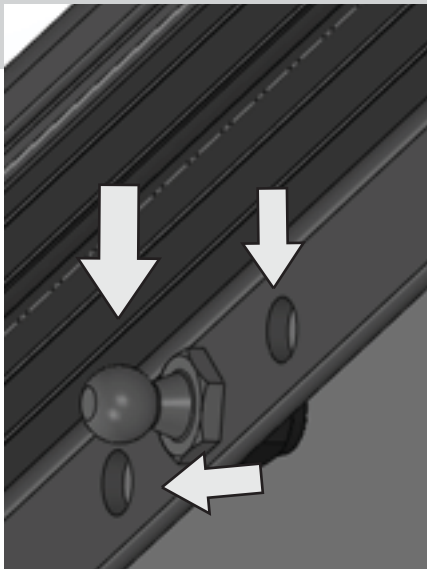

Wide end
Mounts to
Tonneau Cover

Thin end
Mounts to
Vehicle Tub

Required tools: 13mm spanner, 13mm socket and driver

1. Install the ball stud with supplied nut and washer in the middle hole of the Tonneau.
2. Repeat for other side.
3. Connect both gas struts by pressing it's end into the ball studs.

NOTE: Note, the opening height of the tonneau cover can be adjusted by fixing the ball studs in either holes illustrated.

NOTE: Ensure the gas strut is installed in the correct orientation as shown. The wide end connects to the Tonneau cover.

Step 9



Required tools: -

1. Install the cover by letting the hinge tongue to rest on front of the hinge groove while holding the cover in a 60° angle.
2. Move the cover toward the vehicle cabin to slide the tongue to the groove, ensure hinge parts fully engage.

DO NOT LOWER THE COVER YET.

NOTE: When lowering the cover, ensure the front seal is not crushed between the front rail and the cover.

Step 10

Required tools: -

1. While holding the cover up, insert the gas strut ends the brackets, by firmly pushing them in.

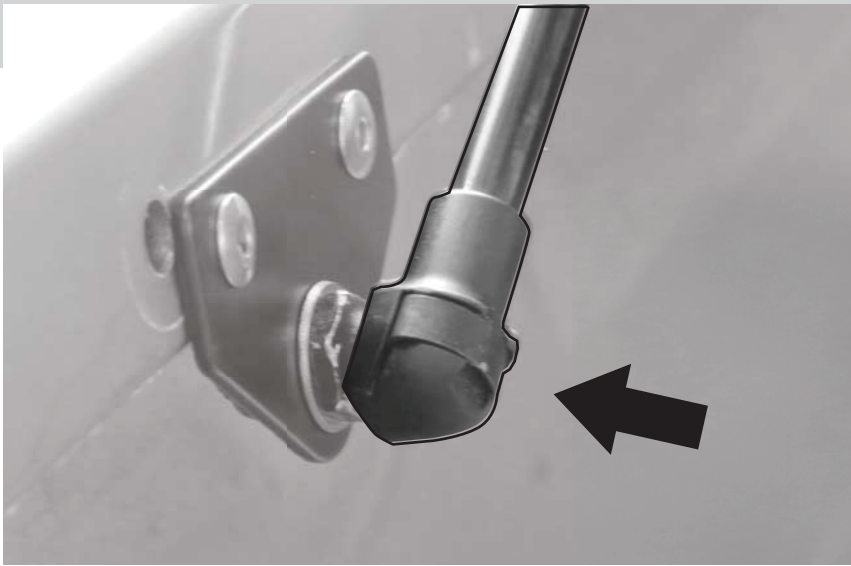

Step 11

Required tools: -

1. Close the cover by pulling from the handle and slowly close it while checking that the cover is correctly lined up to the tub and the latch mechanisms are not touching the tub's side rails.
2. Once confirmed the cover is lined up correctly, leave it fully open.

NOTE: If the cover does not line up correctly, move hinge parts mounted to the front rail forward or backward, one at the time.



Step 12

Required tools: 8mm Spanner.

1. While the cover is open and tailgate is open. Press the latch rotor to closed position, both sides.
2. Rotate the handle slowly to clock-wise, ensure both latches disengage at the same time. Adjustment may be required.

NOTE: Mechanism can be adjusted by tightening or loosening the latch rod M5 nuts from underneath the cover.



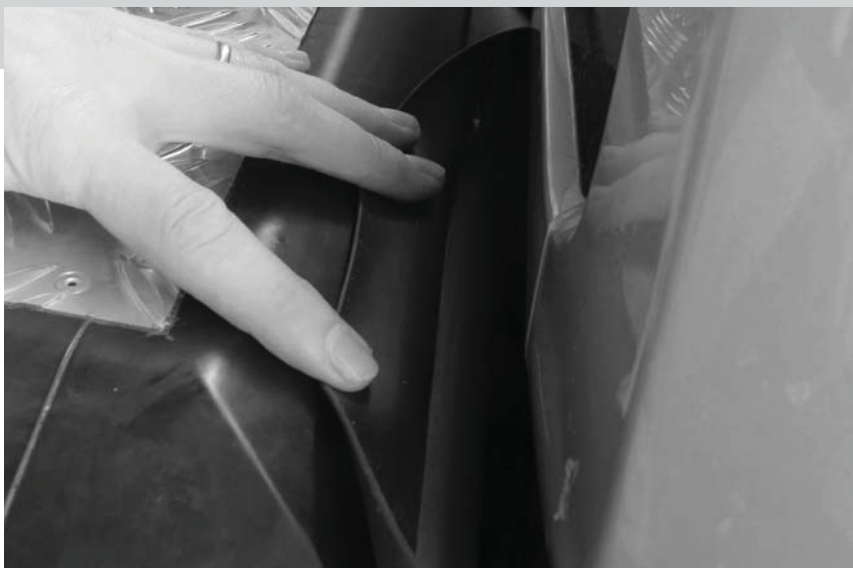

Step 13

Required tools: -

1. While the cover is open, check the front seal's lip is not trapped between the cover and the front rails by bending it up.

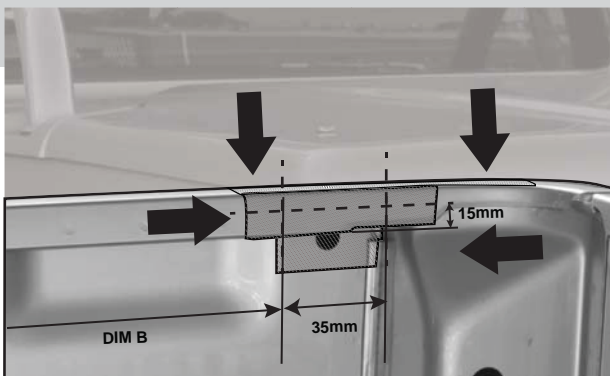

Step 14

Required tools: Masking Tape, Marker Pen, and Tape Measure.

1. Apply masking tape to the rear section of the side rails and side wall below.
2. Select the relevant 'DIM B' for your vehicle from the table below. Starting at the front rail inner surface, use the relevant 'DIM B' to make a mark on the inner side rail as shown.
3. Mark another line 35.0 mm, towards the tailgate.
4. Mark one more line 15.0 mm from the side rail bottom edge, crossing two previously marked lines.

Vehicle	DIM B
FOR RNGR Double Cab	1277mm
FOR RNGR Super Cab	1572mm
MAZ BT50 Dual Cab	1277mm
MAZ BT50 Freestyle Cab	1572mm

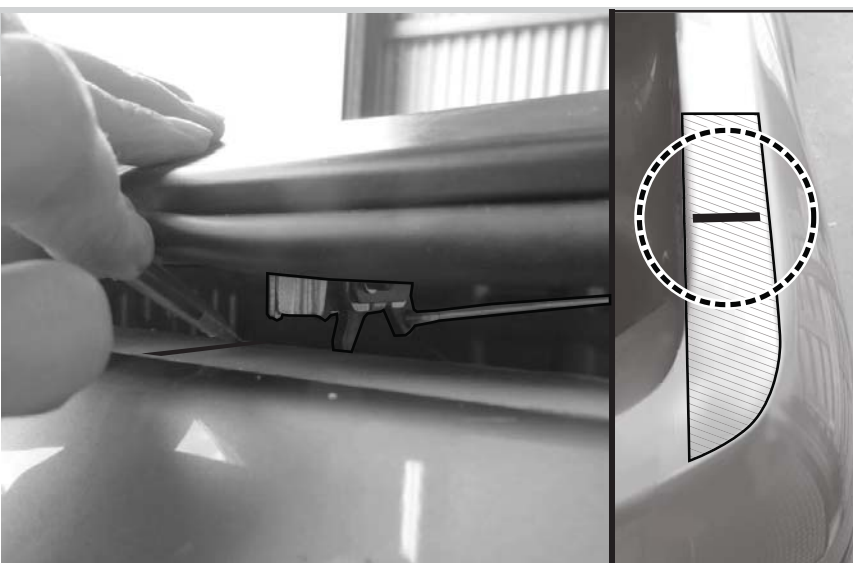

Step 15

Required tools: Marker Pen

1. Lower the tonneau cover. Mark the centre of the tonneau cover latch on the masking tape on the top surface of the side rail.

Step 16

Required tools: Marker pen.

1. Take the striker bracket and line up the top holes with marked location in the side rail.
2. Mark up the bottom hole location, using the bracket as template.
3. Repeat for other side.
4. Ensure bracket top surface is horizontal and that the line marked in step 14 lines up with the centre of the bracket.

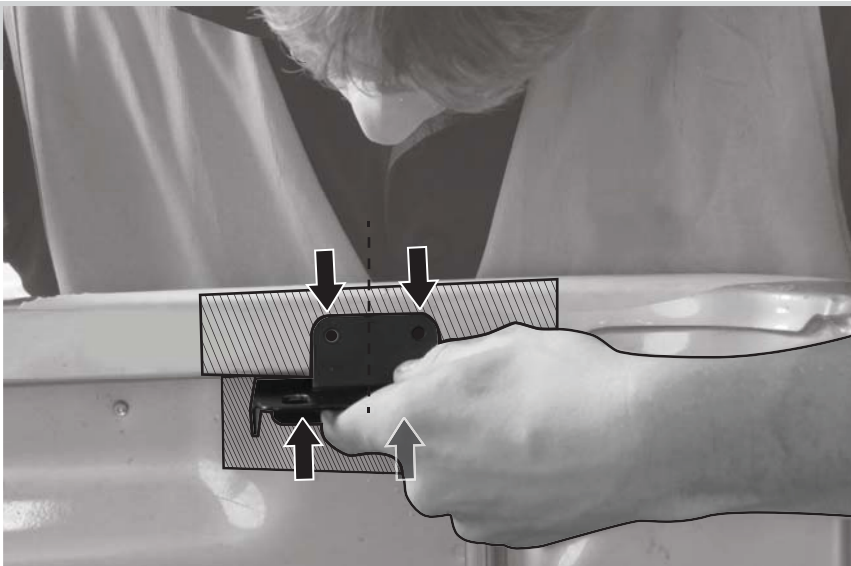

Step 17

Required tools: Power drill, 5mm drill bit and drill bit stopper, centre punch, hammer.

1. Remove the bracket, take centre punch and centre punch the hole locations, 4x per side.
2. Using 5.0 mm drill bit, drill the holes, only through the first layer of steel. Remove any drill burr from the holes.
3. Repeat for other side.
4. Apply rust inhibitor to the drilled holes.

NOTE: Use drill stopper to avoid drilling too deep.



Step 18

Required tools: Rivet gun.

1. Install the bracket using supplied rivets.

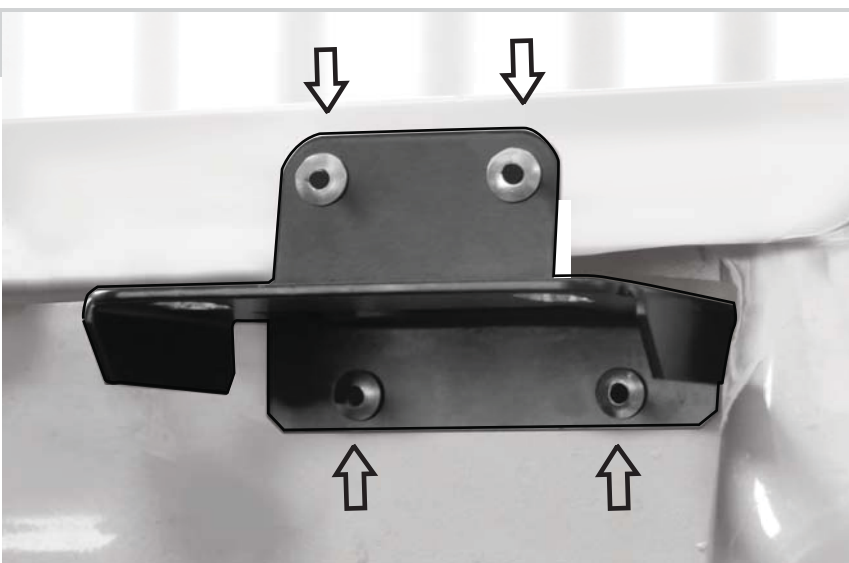

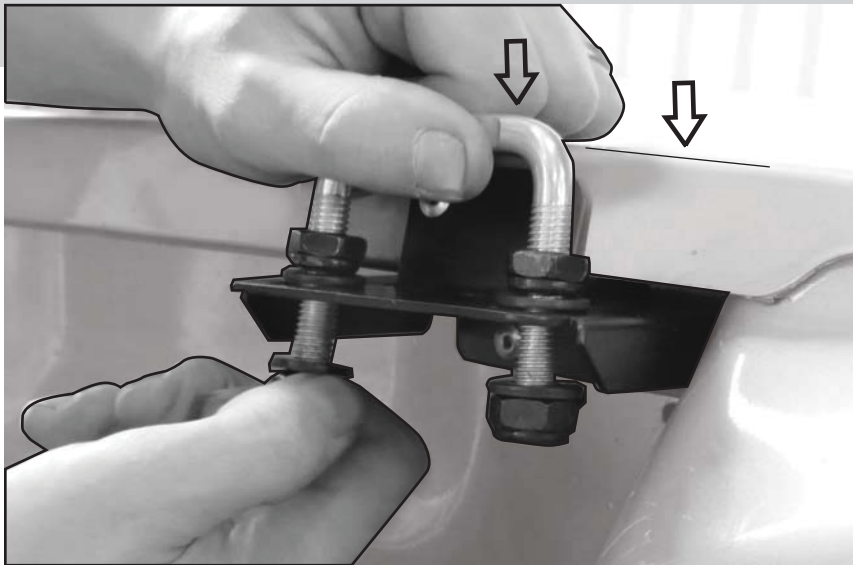

Step 19

Required tools: 17mm spanner, 17mm socket and driver.

1. Install the striker to the striker bracket using supplied hardware.
2. The striker should line up with the top surface of the side rails, fine adjustment required.

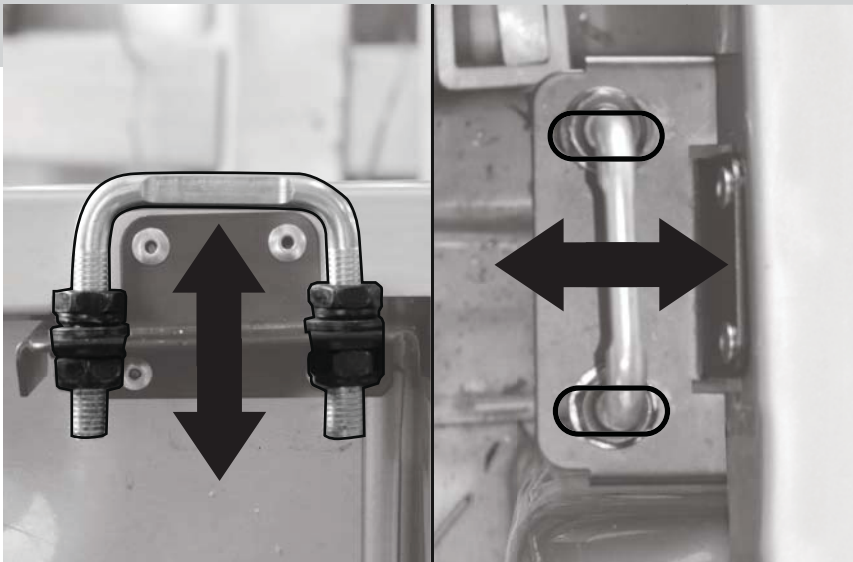

Step 20

Required tools: -

NOTE: Do Not Close the tailgate.

1. Slowly close the cover and move the striker sideways to line it up with the latches. Ensure both sides are lined correctly.
2. Adjust the striker height correct by first closing the cover and measuring the gap between the cover and side rails top surface. The gap should be 9.0 mm at the rear, adjust strikers accordingly.
3. Tighten the striker nuts to 30.0Nm.



Step 21 (Optional)

Required tools: -

NOTE: Tailgate locking brackets are included for added security, if you do already have tailgate lock installed or do not require this feature, please go to step 26.

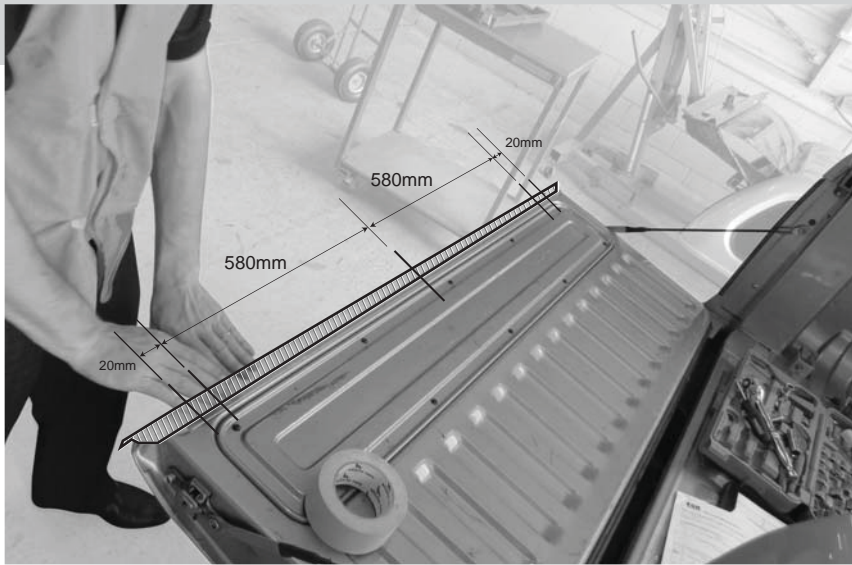

Step 22 (Optional)

Required tools: Masking tape, marker pen, and tape measure.

1. Apply masking tape on both corner of the tailgate top surface and first 30 mm of inner surface.
2. Mark a centre line accurately. Mark lines 580.0mm from the centre line to both sides.
3. Mark another line 20.0 mm outboard from this line.



Step 23 (Optional)

Required tools: Marker Pen.

1. Align tailgate lock bracket with marked lines to confirm hole location.
2. Use the other bracket to create a gap between the tailgate top surface and tailgate lock bracket. as shown. Mark the centre of the two holes.
3. Repeat for the other side.

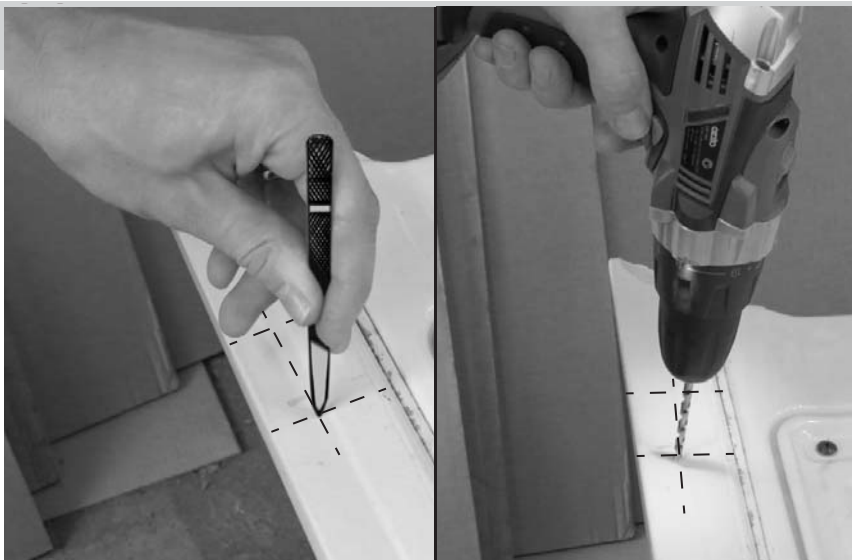

Step 24 (Optional)

Required tools: Centre punch, hammer, drill, 5mm drill bit, drill bit stopper.

1. Centre punch the hole locations (4x)
2. Drill holes using a 5.0 mm drill bit and drill stopper.
3. Remove drill burr from the holes.
4. Apply rust inhibitor to the drilled holes.

Step 25 (Optional)

Required tools: Rivet gun.

1. Install the tailgate lock brackets with supplied rivets.



Step 26

Required tools: -

1. Ensure all the parts are correctly installed.
2. Open the tailgate.
3. Close the cover slowly and ensure locking mechanism functions correctly.
4. Repeat step 3 ten times.
5. Fully open the cover.
6. Close the tailgate.
7. Close the cover again slowly ensuring the tailgate lock brackets are lined up correctly (if installed) and the cover closes fully.

NOTE: Ensure the keys do not get locked inside the tub.



Step 27

Required tools: -

1. Ensure the gas strut is installed in the correct orientation as shown. The wide end connects to the Tonneau cover.

NOTE: Incorrect installation of gas strut will void Tonneau Cover warranty.

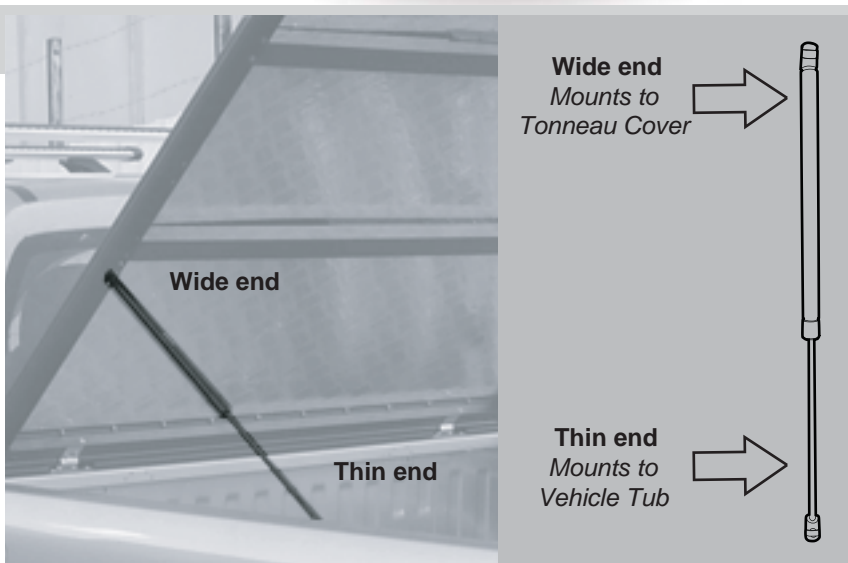

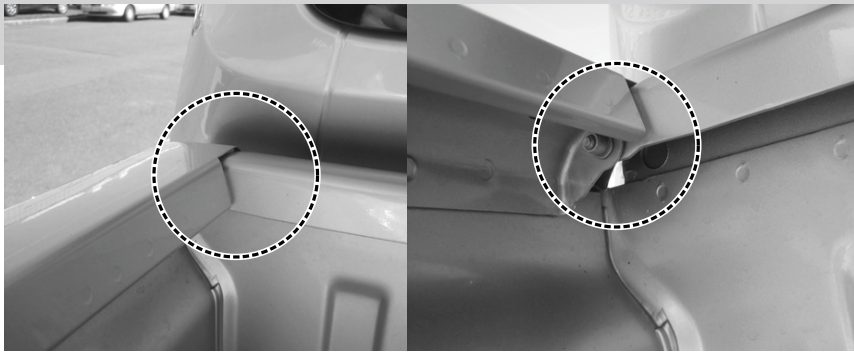

Step 28

Required tools: scissors.

1. Use supplied foam seal to improve weather resistance of the tub when required. Silicone may be applied to seal smaller gaps.

NOTE: Common area of water ingress is the seam between the side and front panels.